

# EKI-2525 / I

# EKI-2528 / I

## 5-port Unmanaged Industrial Ethernet Switch

## 8-port Unmanaged Industrial Ethernet Switch



### Features

- Provides 5/8 Fast Ethernet ports with Auto MDI/MDI-X
- Supports 10/100 Mbps Auto-Negotiation
- Provides compact size with DIN-rail/Wall mount, and IP30 metal mechanism
- Supports redundant 12 ~ 48 V<sub>DC</sub> power input and P-Fail relay
- Supports wide operating temperatures from -40 to 75 °C (EKI-2525I/EKI-2528I)

### Introduction

The EKI-2525/2528 is a Fast Ethernet solution. Power is a +12 ~ 48 V<sub>DC</sub> redundant input design, and is secured with a double protection mechanism: Power Polarity Reverse Protection and Overload Current Resettable Fuse. The former tolerates reverse power switching while the later secures the system from overload currents. As the power supply turns normal, EKI-2525/2528 will automatically get back to work. Each EKI-2525/2528 port has 2 LED's to show the link status transmission speed and collision status. It also provides a relay output for an event alarm. In the event of a power failure, the built-in LED will activate the alarm to notify administrators. Engineers can simply verify the hardware status by checking the LED, which makes troubleshooting quick and easy. EKI-2525/2528 comes with a compact metal IP30 rated housing to protect against dusty industrial environments.

### Specifications

#### Communications

- **Standard IEEE** 802.3, 802.3u, 802.3x
- **LAN** 10/100Base-T (X)
- **Transmission Distance** Up to 100 m
- **Transmission Speed** Up to 100 Mbps

#### Interface

- **Connectors** 8 x RJ45 (EKI-2528) or 5 x RJ45 (EKI-2525)  
6-pin removable screw terminal (power & relay)
- **LED Indicators** P1, P2, P-Fail  
10/100T (X): Link/Activity, Duplex/Collision

#### Power

- **Power Consumption** EKI-2525/I: 2.88 Watts  
EKI-2528/I: 4.71 Watts
- **Power Input** 12 ~ 48 V<sub>DC</sub>, redundant dual inputs
- **Fault Output** 1 Relay Output

#### Mechanism

- **Dimensions (W x H x D)** EKI-2525: 30 x 120 x 95 mm (1.18" x 4.72" x 3.74")  
EKI-2528: 30 x 140 x 95 mm (1.18" x 5.51" x 3.74")
- **Enclosure** IP30, Metal shell with solid mounting kits
- **Mounting** DIN-rail, Wall

#### Protection

- **Reverse Polarity** Present
- **Overload current** Present

#### Environment

- **Operating Temperature** -10 ~ 60 °C (14 ~ 140 °F)  
-40 ~ 75 °C (-40 ~ 167 °F), (EKI-2525I and EKI-2528I)
- **Storage Temperature** -40 ~ 85 °C (-40 ~ 185 °F)
- **Operating Humidity** 10 ~ 95% (non-condensing)
- **Storage Humidity** 10 ~ 95% (non-condensing)
- **MTBF** 820,306 hours (EKI-2528/I)  
412,590 hours (EKI-2525/I)

#### Certification

- **Safety** UL 60950
- **EMI** CE, FCC Class A
- **EMS** EN 61000-4-2  
EN 61000-4-3  
EN 61000-4-4  
EN 61000-4-5  
EN 61000-4-6  
EN 61000-4-8  
Shock IEC 60068-2-27  
Freefall IEC 60068-2-32  
Vibration IEC 60068-2-6

## Dimensions

Unit: mm

### EKI-2525/I

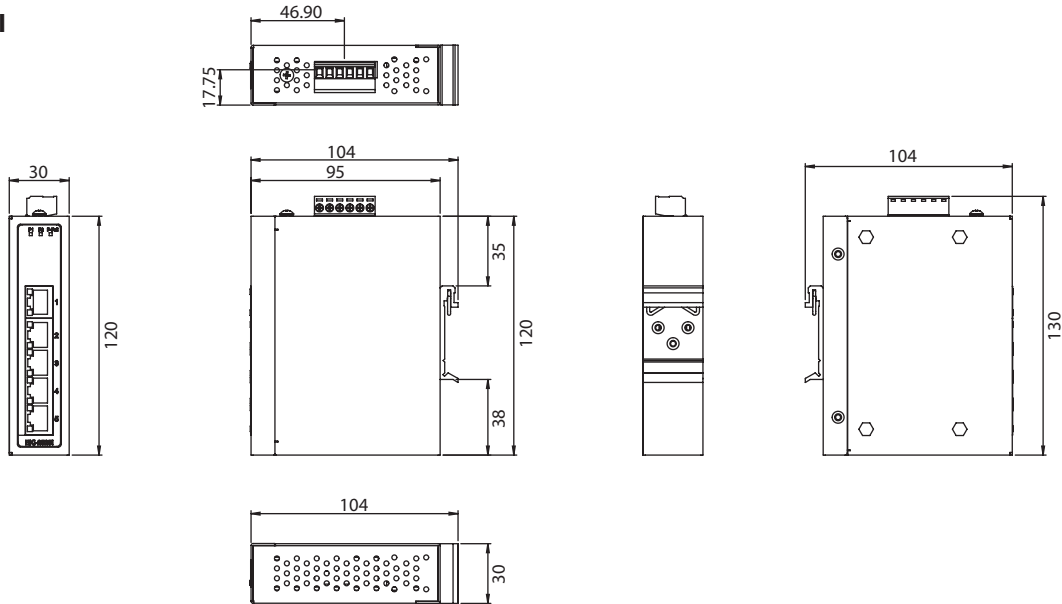

**Panel Cut-out Dimensions: 30 x 120 x 95 mm (1.18" x 4.72" x 3.74")**

### EKI-2528/I

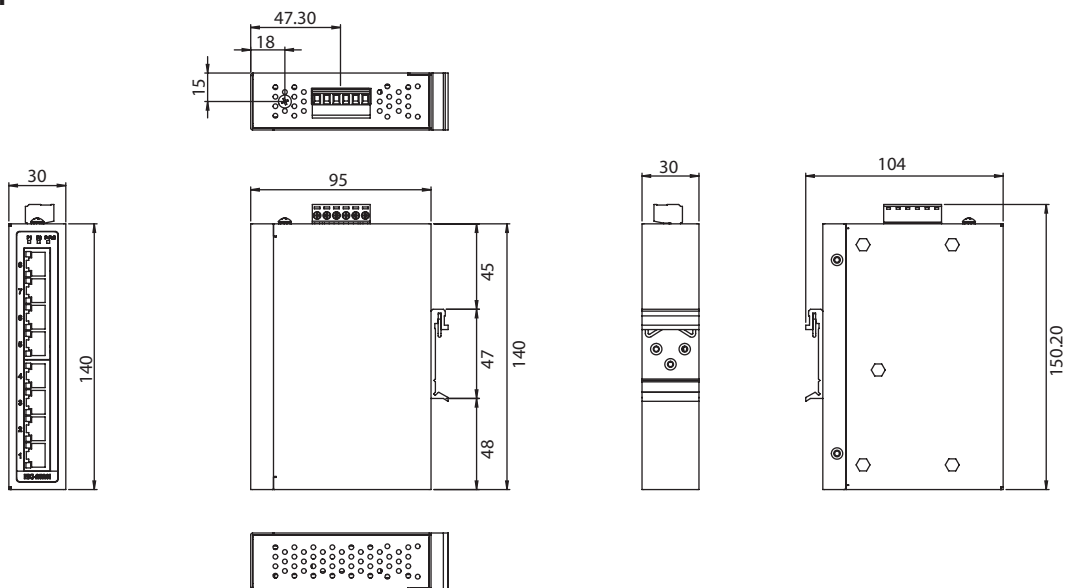

**Panel Cut-out Dimensions: 30 x 140 x 95 mm (1.18" x 5.51" x 3.74")**

## Ordering Information

- EKI-2525-BE 5-port Ethernet Switch
- EKI-2525I-BE 5-port Ethernet Switch w/ Wide Temp
- EKI-2528-BE 8-port Ethernet Switch
- EKI-2528I-BE 8-port Ethernet Switch w/ Wide Temp